



# SHARLIGHT ELECTRONICS CO., LTD.

## SPECIFICATION FOR APPROVAL

Part No. : SLM-5630LR40-01-NN

### Package Dimensions

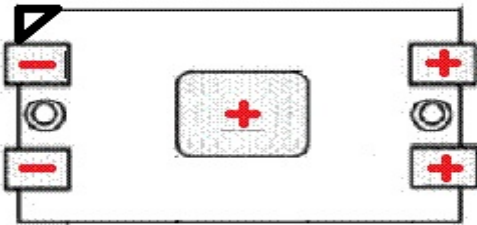
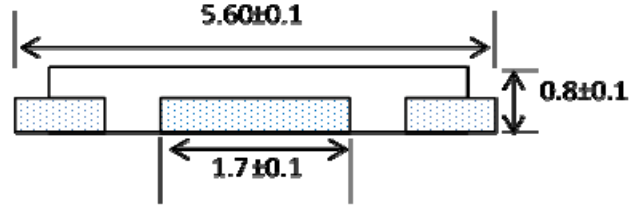
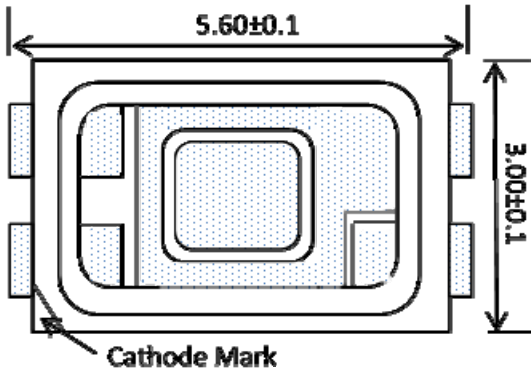

※Soldering pad pattern

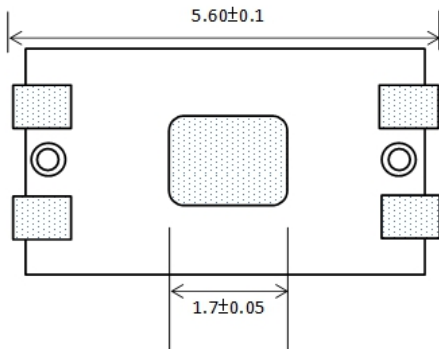

※Metal solder stencil aperture

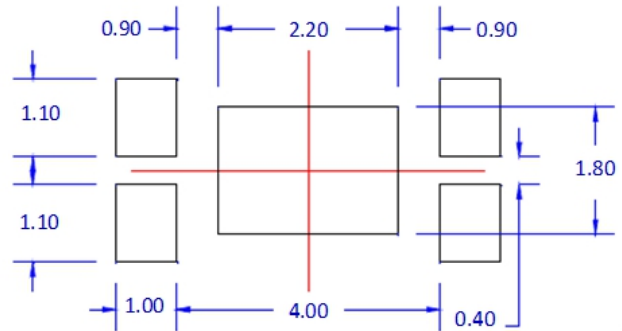

NOTE : All dimensions in mm tolerance is  $\pm 0.1$  mm unless otherwise noted.

Part NO.	Chip Material	Lens Color	Emission Color
SLM-5630LR40-01-NN	AlGaInP	Water Clear	Red



# SHARLIGHT ELECTRONICS CO., LTD.

## SPECIFICATION FOR APPROVAL

Part No. : SLM-5630LR40-01-NN

### Absolute Maximum Rating

Tc=25°C

Parameter	Symbol	Rating	Unit
Optical Output	Po	<b>5</b>	mW
Reverse Voltage	Vr	<b>2</b>	V
Operating Temperature ( Case )	Top	-10~+70	°C
Storage Temperature	Tstg	-40~+85	°C

### Electrical and Optical Characteristics

Parameter	Symbol	Condition	Min.	Typ.	Max.	Unit	
Threshold Current	Ith	Po=5mW	-	<b>12</b>	<b>15</b>	mA	
Operating Current	Iop	Po=5mW	-	<b>17</b>	<b>20</b>	mA	
Operating Voltage	Vop	Po=5mW	-	<b>2.2</b>	<b>2.5</b>	Volts	
Slope Efficiency	$\eta$	Po=1.5-5mW	<b>0.7</b>	<b>1</b>	-	mW/mA	
Beam Divergence (FWHM)	Parallel	$\theta_{//}$	Po=5mW	<b>5</b>	<b>7.5</b>	<b>12</b>	deg.
	Perpendicular	$\theta_{\perp}$	Po=5mW	<b>30</b>	<b>36</b>	<b>42</b>	deg.
Lasing Wavelength	$\lambda$	Po=5mW	<b>640</b>	<b>650</b>	<b>660</b>	nm	

©  $\theta_{//}$  and  $\theta_{\perp}$  are defined as the angle within which the intensity is 50% of the peak value.

### Product features:

1. The world's first SMD form of edge-fired laser package: 5630 package.
2. Output Wavelength : 650nm / 808 nm / 850nm / ...
3. Standard optical power output energy : 5 mW ◦
4. High temperature operation.
5. Single Mode Lasing output.

### Application:

1. Laser module
2. Biomedical applications

LISTER : 周素華 03-28-18

EDITOR : 03-28-18

DATE : 03-28-18

REV : A



# SHARLIGHT ELECTRONICS CO., LTD.

## SPECIFICATION FOR APPROVAL

Part No. : SLM-5630LR40-01-NN

### Optical characteristics

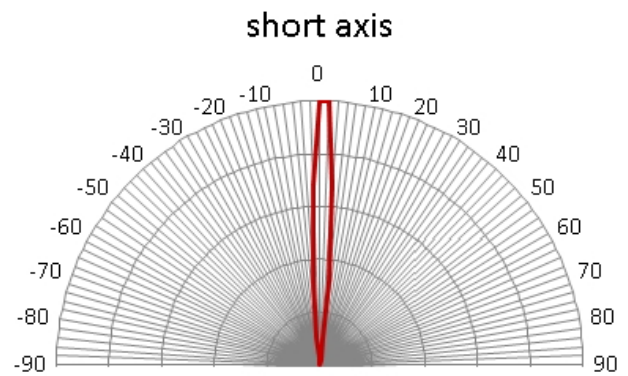
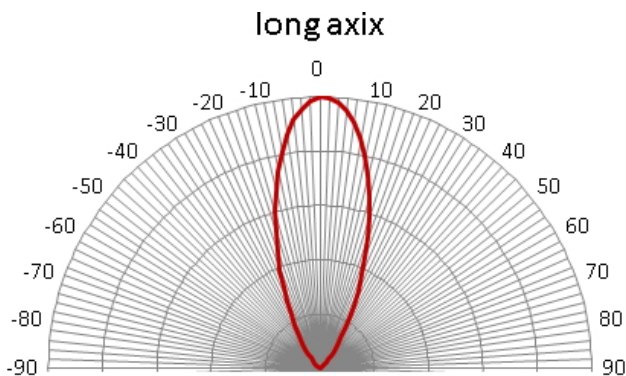
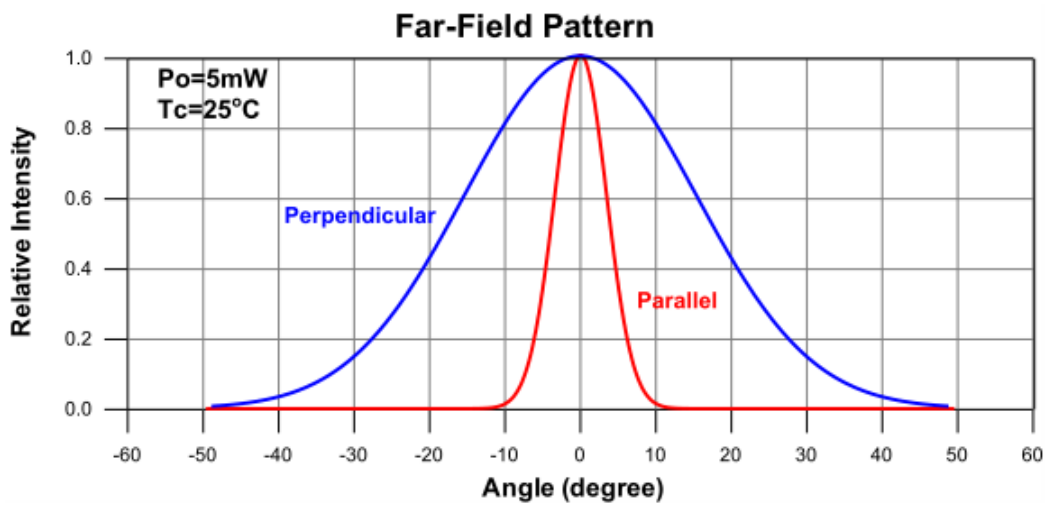
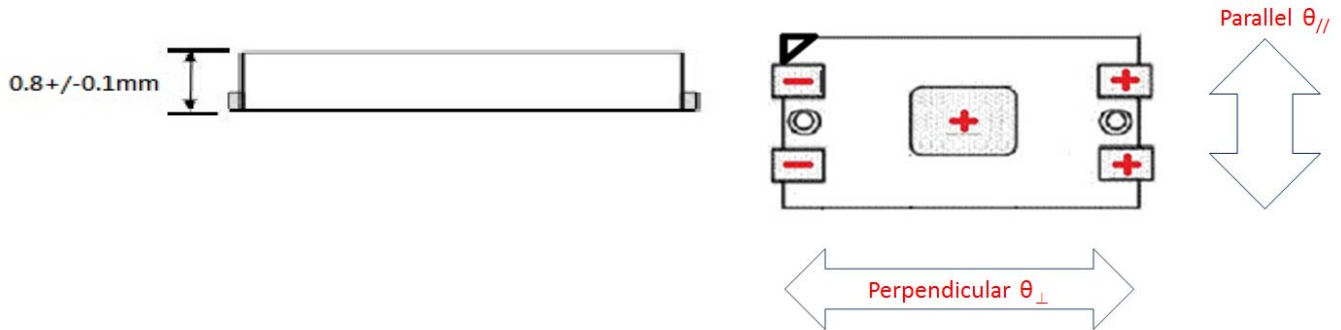



# SHARLIGHT ELECTRONICS CO., LTD.

## SPECIFICATION FOR APPROVAL

Part No. : SLM-5630LR40-01-NN

### Typical Characteristic Curves

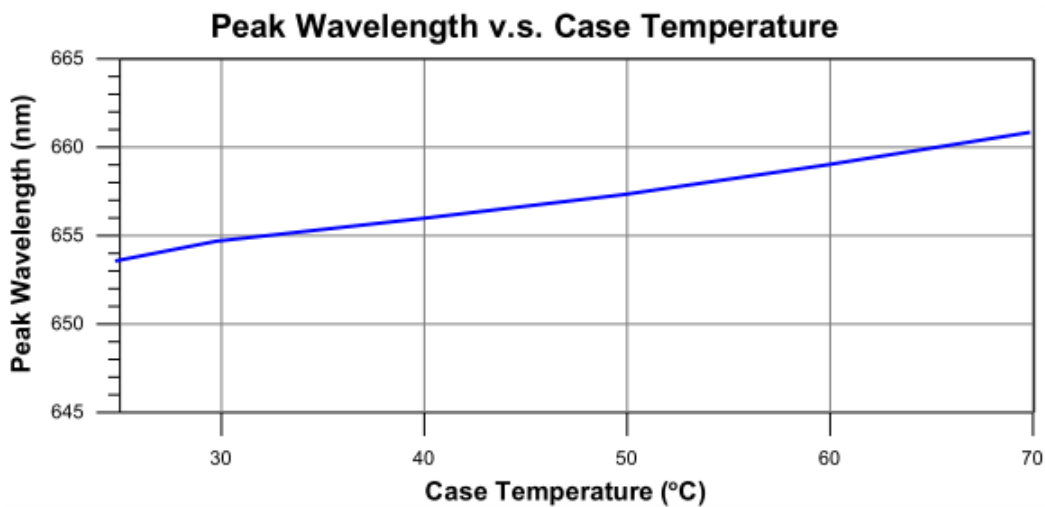
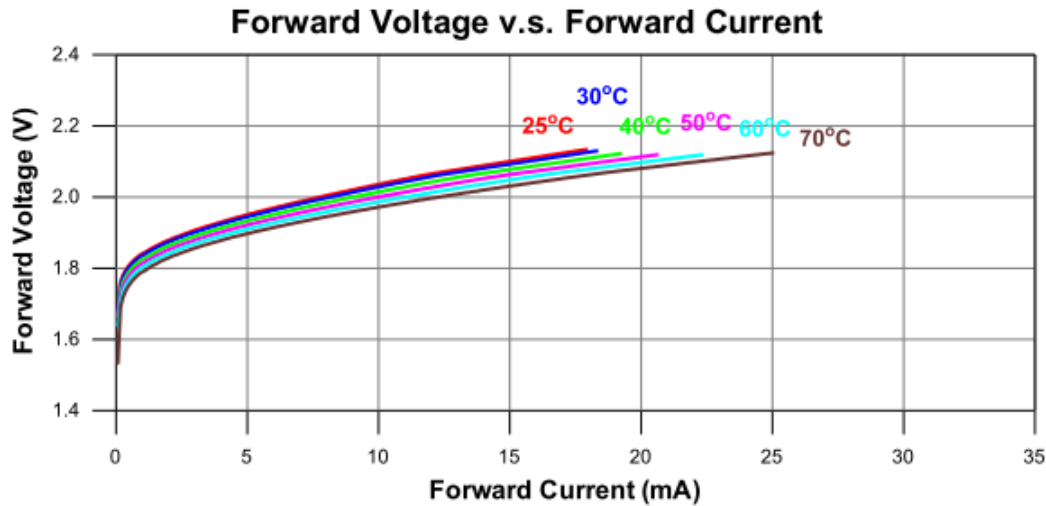
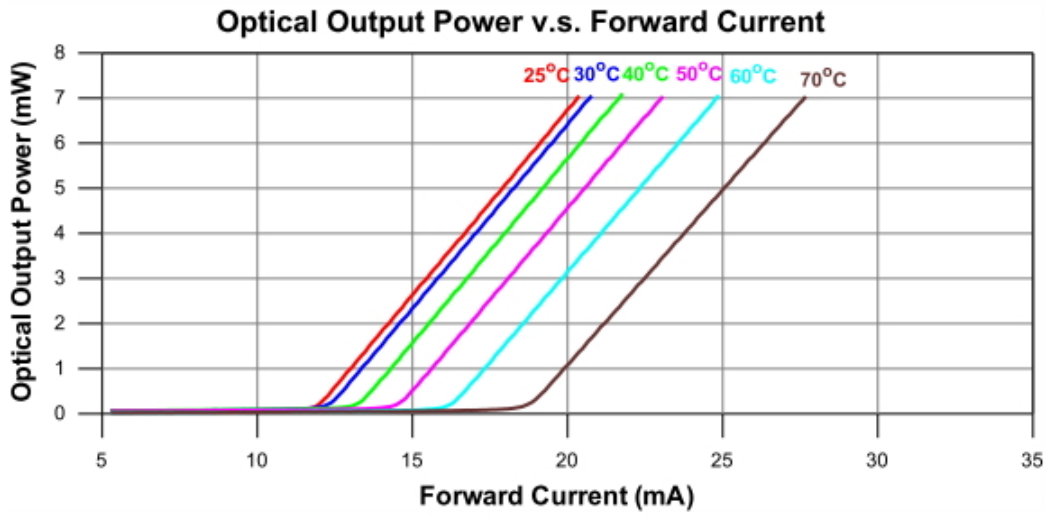



# SHARLIGHT ELECTRONICS CO., LTD.

## SPECIFICATION FOR APPROVAL

Part No. : SLM-5630LR40-01-NN

### Slope Efficiency v.s. Case Temperature

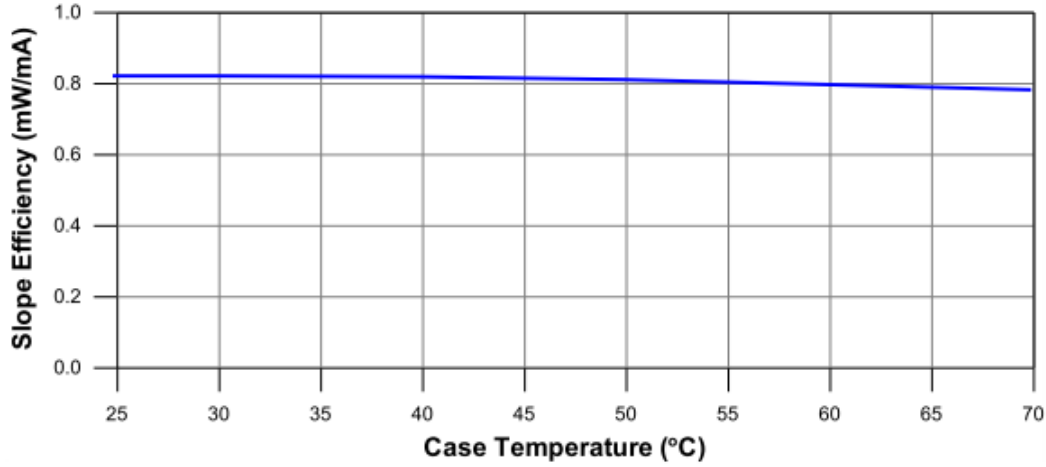

### Threshold Current v.s. Case Temperature

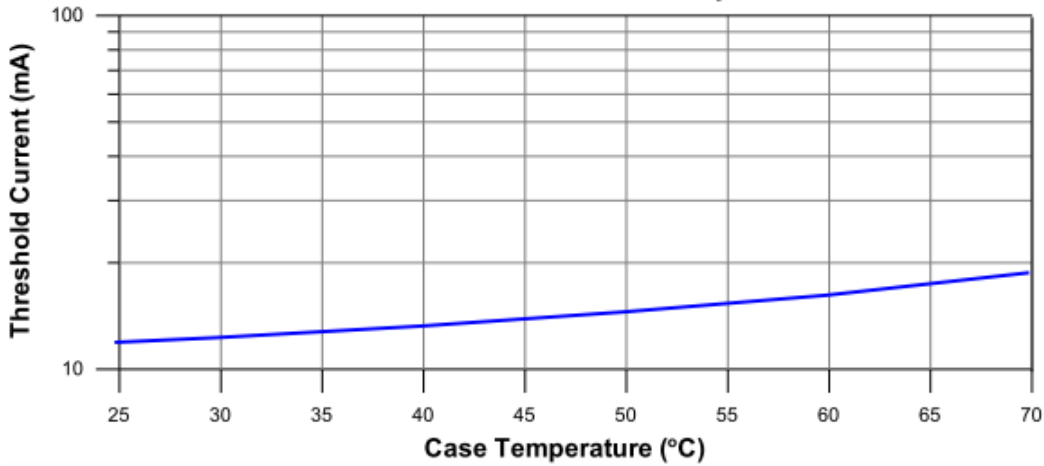

### Power vs. Temperature

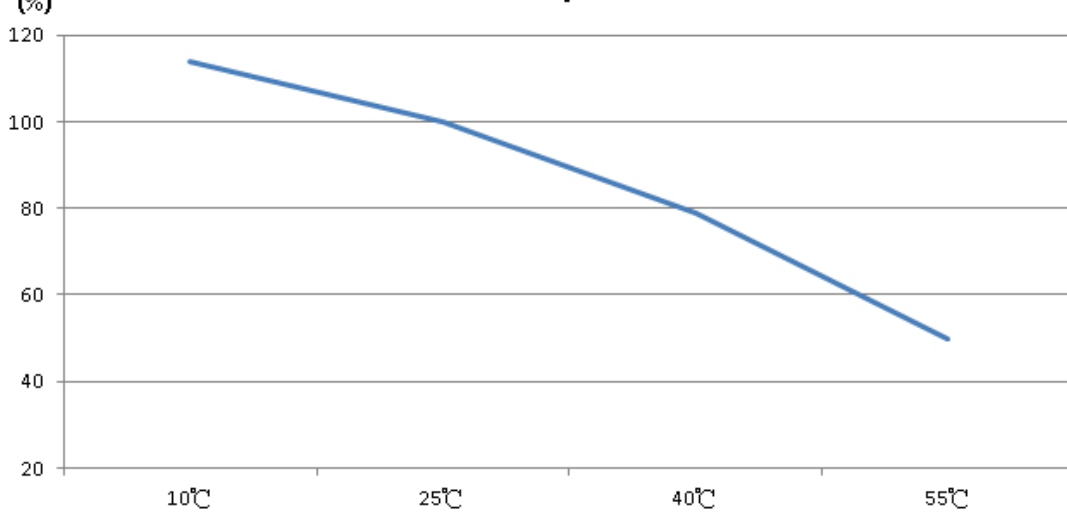

LISTER : 周素華 03-28-18

EDITOR : 03-28-18

DATE : 03-28-18

REV : A



# SHARLIGHT ELECTRONICS CO., LTD.

SPECIFICATION FOR APPROVAL

Part No. : SLM-5630LR40-01-NN

## Package

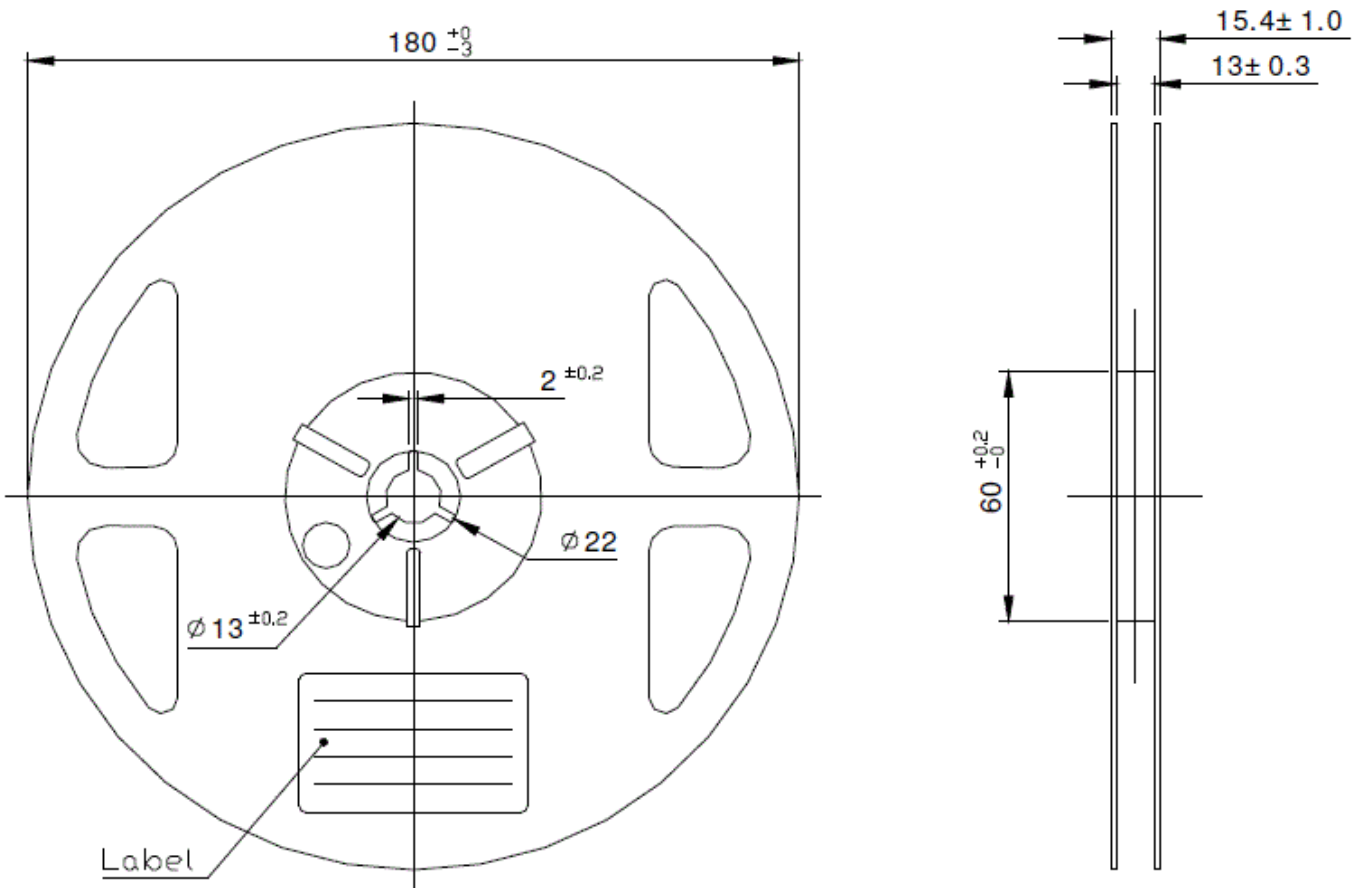
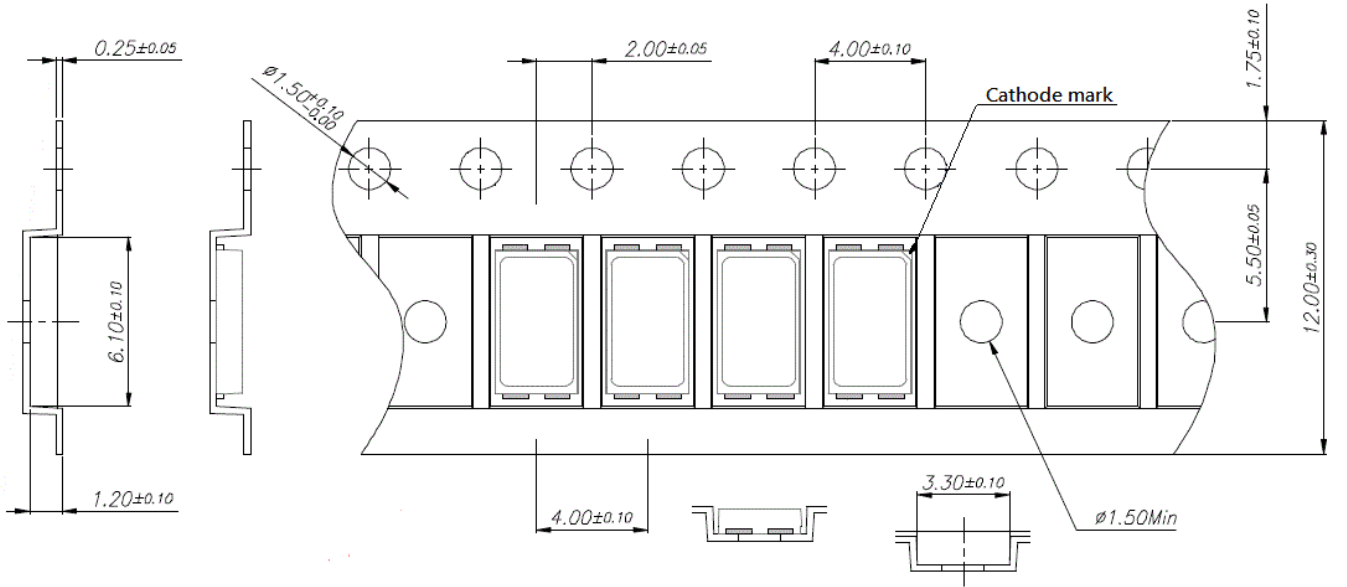

( Tolerance:  $\pm 0.2$ , Unit: mm )

LISTER : 周素華 03-28-18

EDITOR : 03-28-18

DATE : 03-28-18

REV : A



**SHARLIGHT ELECTRONICS CO., LTD.**  
SPECIFICATION FOR APPROVAL

Part No. : SLM-5630LR40-01-NN

**※Note :**

**Recommended storage conditions :**

1. Storage Condition:

- a. don't open the sealed bag until the Reflow Soldering ◦
- b. before open the sealed bag, please keep bag at Ambient Temperature from 5 to 25°C and Relative Humidity < 60% ◦
- c. storage life: within 6 months ◦

2. Once overdue the storage life or after open the sealed bag for 12 hours , the LED has to be oven at 70°C for 24 hours before the Reflow Soldering ◦

3. After oven the LED, the Reflow Soldering has to be completed within 12 hours. ◦

Otherwise, the oven LED has to be sealed in bag again and storage at Ambient Temperature of 23 +/- 5°C & RH 5~30% ◦